







LEGENDA

-  PAVIMENTAÇÃO PISO INTERTRAVADO H-4
-  PAVIMENTAÇÃO PISO INTERTRAVADO H-8
-  PAVIMENTAÇÃO PISO INTERTRAVADO H-8
-  ÁREAS VERDES
-  PISO PODOTÁTIL DIRECIONAL
-  PISO PODOTÁTIL ALERTA



SEÇÃO TÍPICA PARA AS RUAS

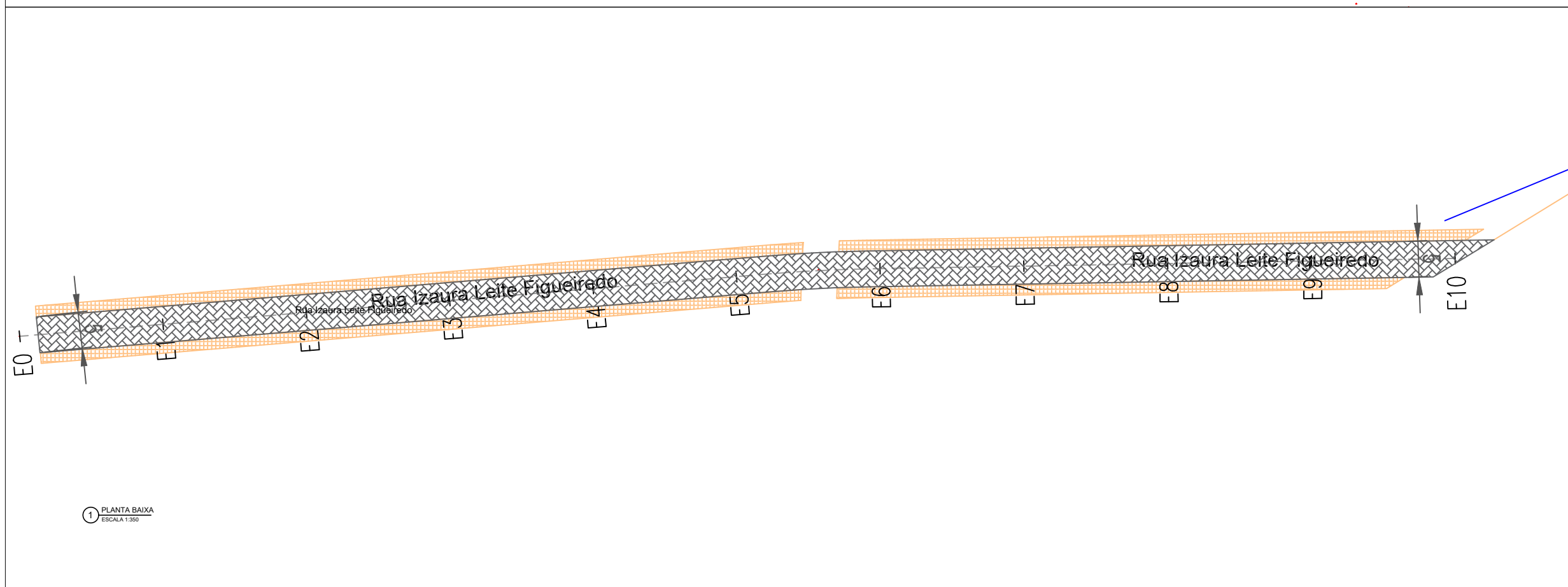
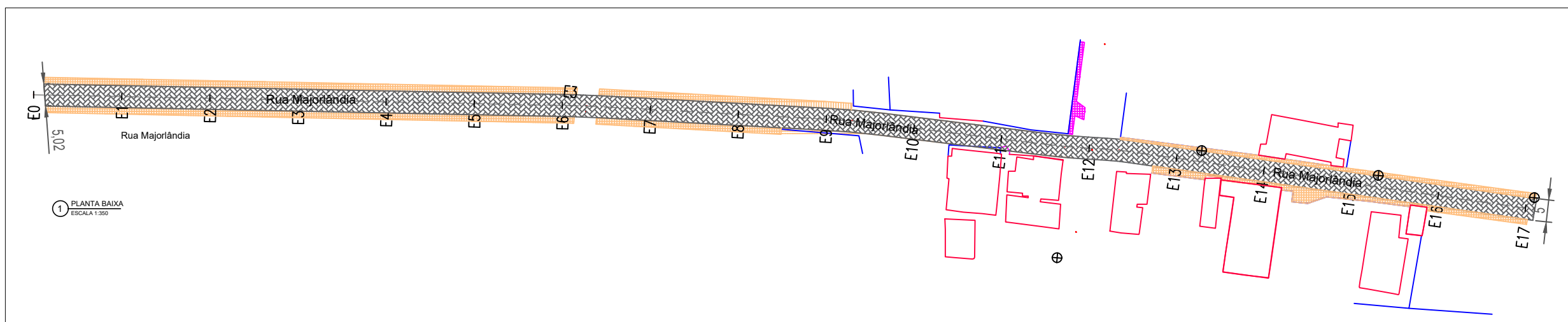
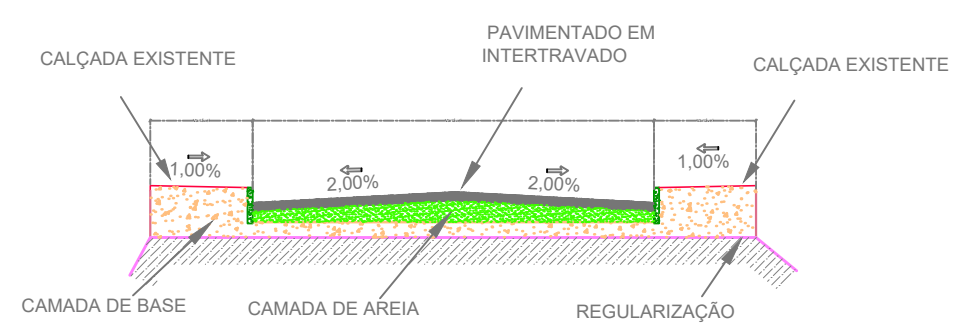

DETALHE DO MEIO-FIO

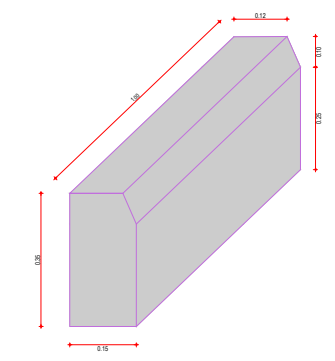

PREFEITURA DO ARACATI
30 DE FEVEREIRO DE 1954

PROJETO EXECUTIVO
ARACATI - MAJORLÂNDIA

FINALIDADE: Projeto Urbanístico
LOCAL: Majorlândia
PROPRIETÁRIO: Prefeitura Municipal de Aracati

MUNICÍPIO: Aracati ESTADO (UF): CE DATA: 27/02/2021

RESPONSÁVEL TÉCNICO: _____ ESCALA: 1:750 FOLHA: 10/11