







-  PAVIMENTAÇÃO PISO INTERTRAVADO H-4
-  PAVIMENTAÇÃO PISO INTERTRAVADO H-8
-  PAVIMENTAÇÃO PISO INTERTRAVADO H-8
-  ÁREAS VERDES
-  PISO PODOTÁTIL DIRECIONAL
-  PISO PODOTÁTIL ALERTA



DETALHE DO MEIO-FIO

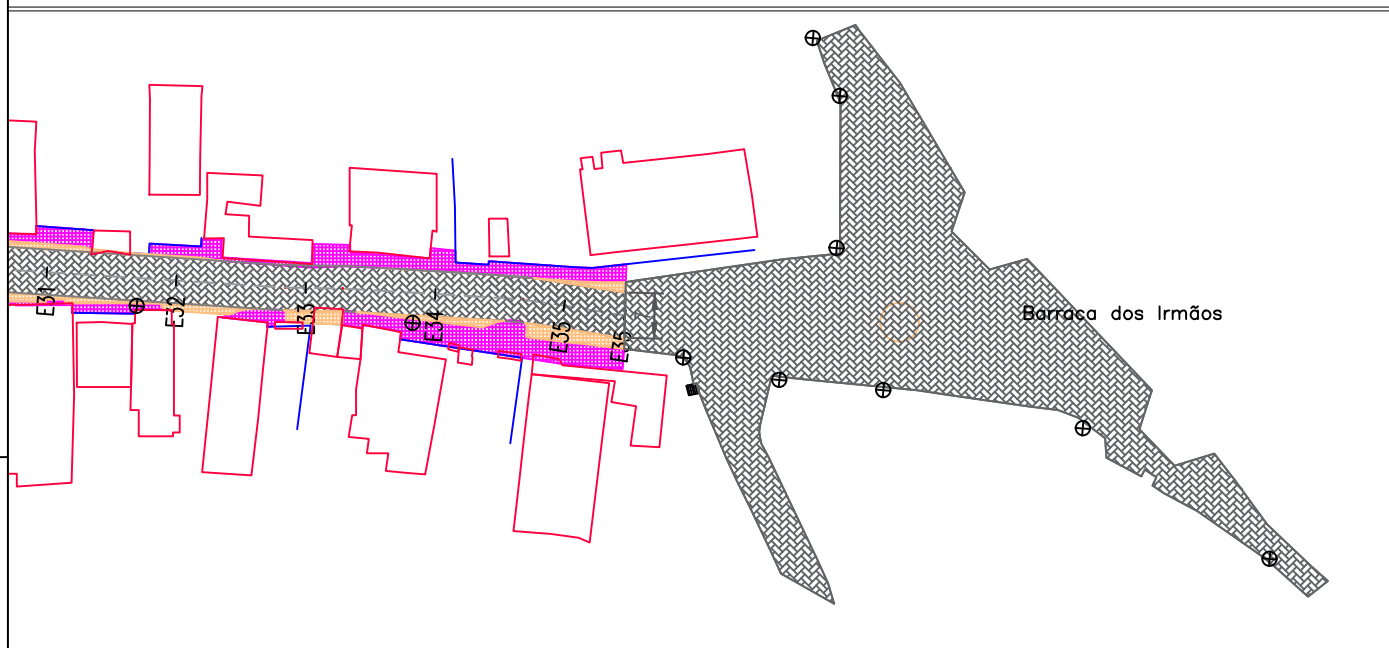
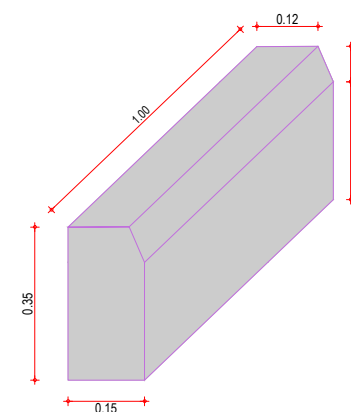

SEÇÃO TÍPICA PARA AS RUAS

