

V1

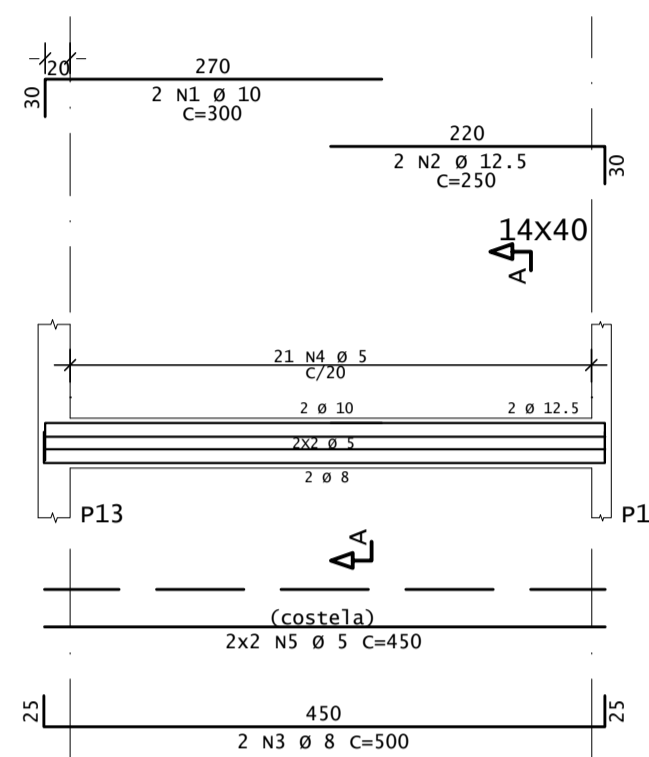

CORTE A

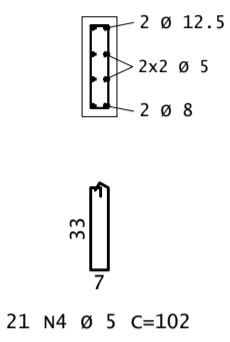

V2

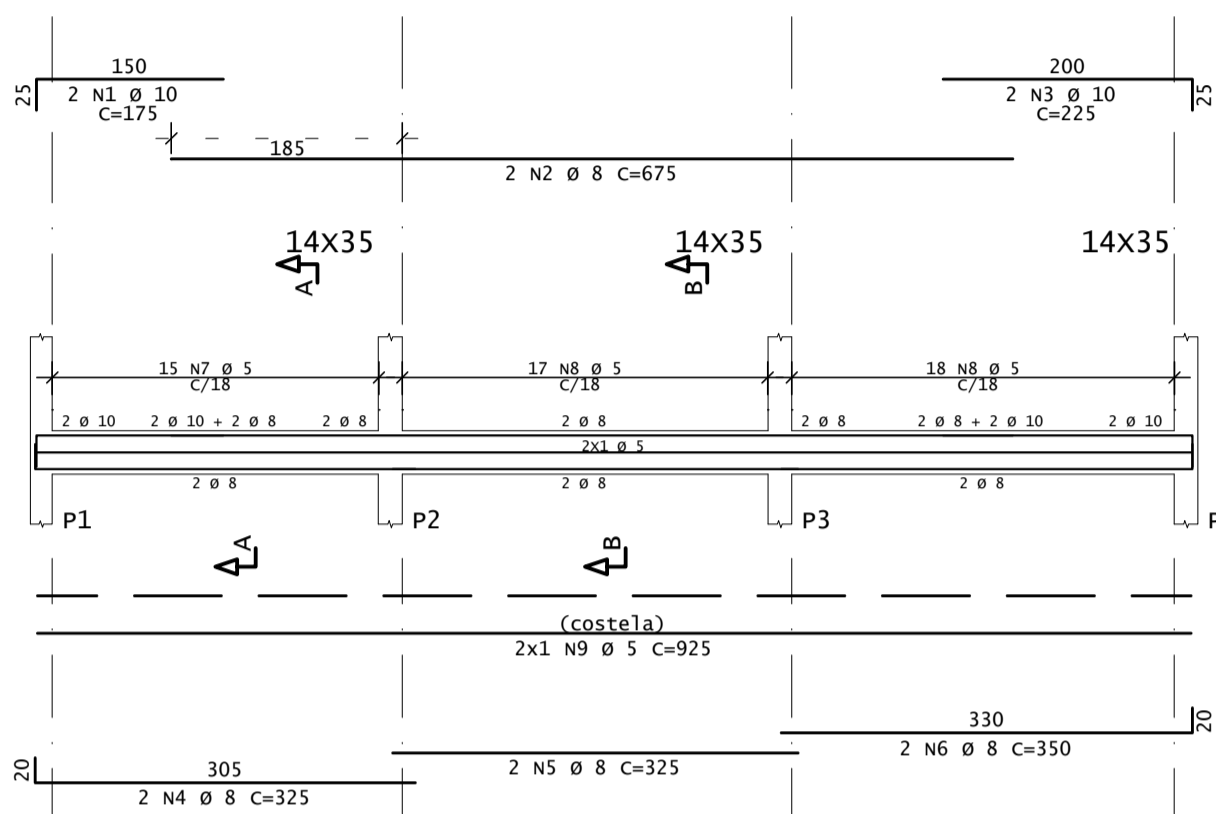

CORTE A

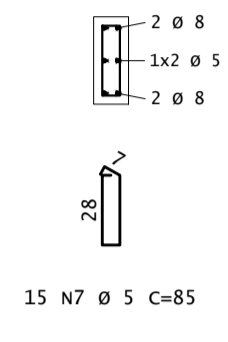

CORTE B

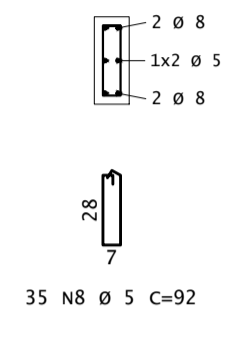

V3

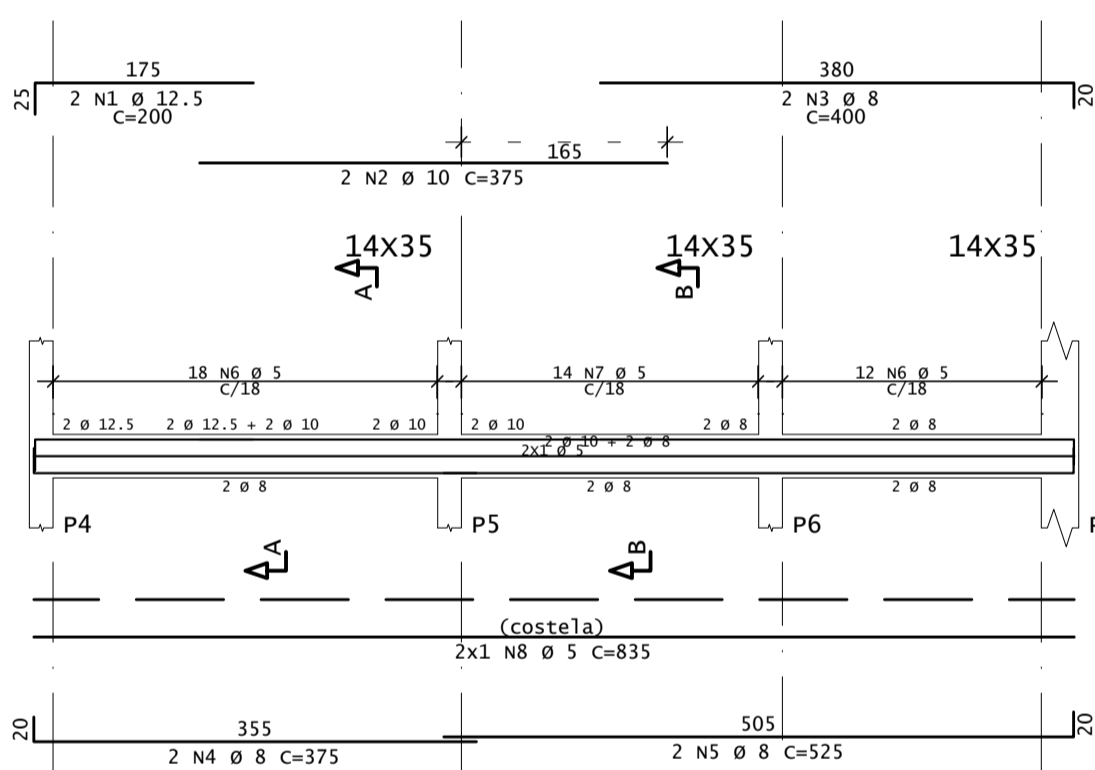

CORTE A

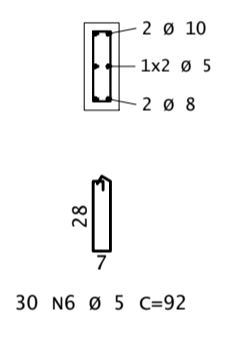

CORTE B

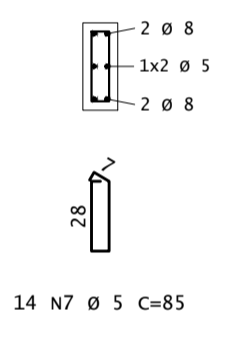

V4

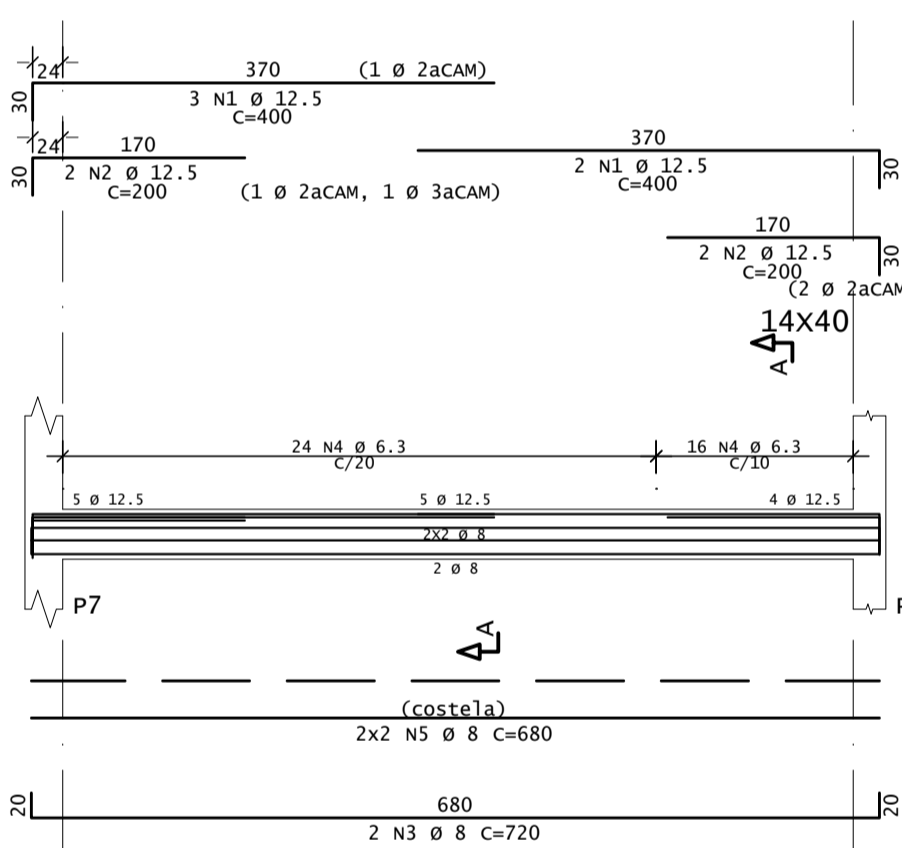

CORTE A

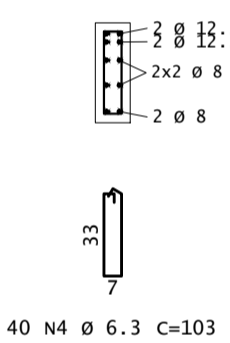

V5

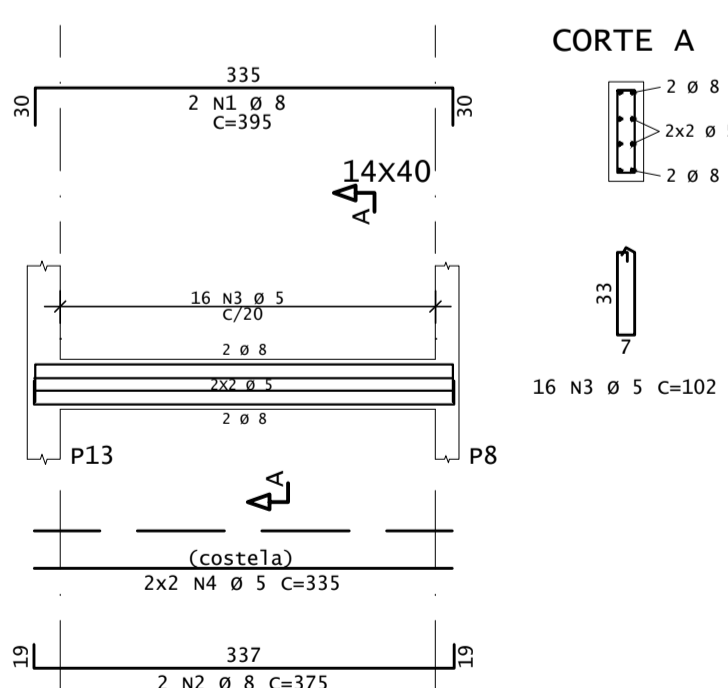

CORTE A

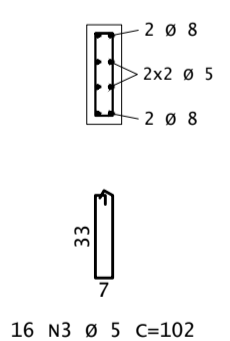

V6

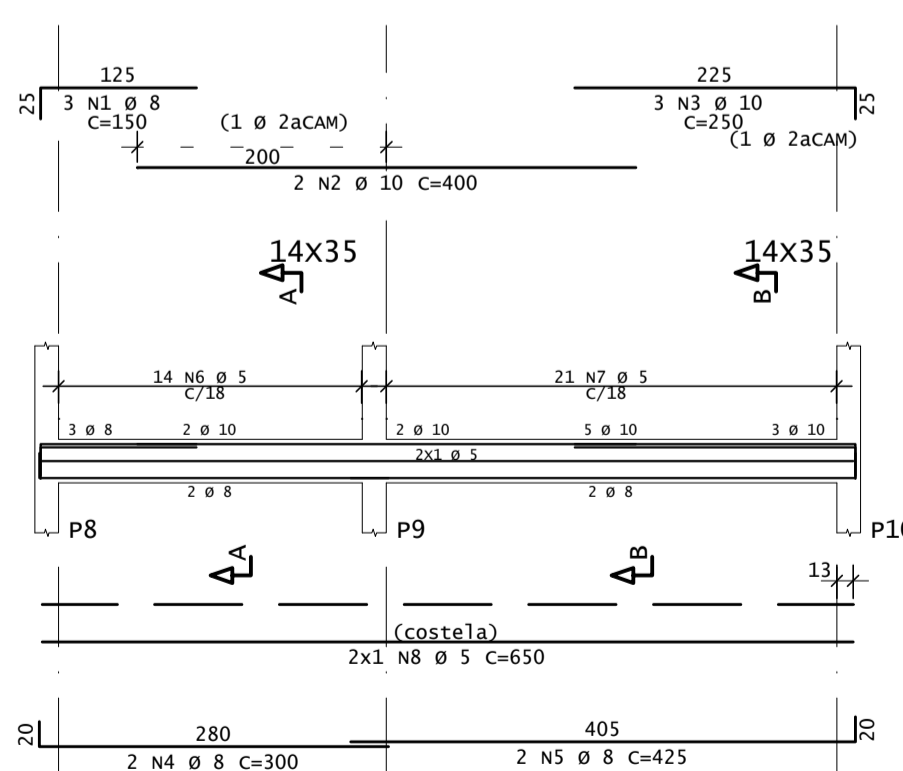

CORTE A

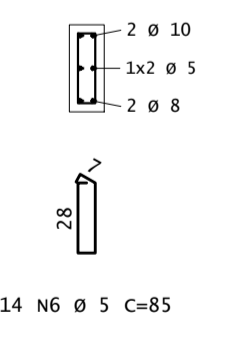

CORTE B

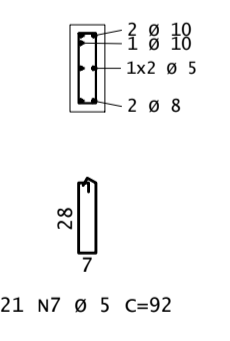

V7

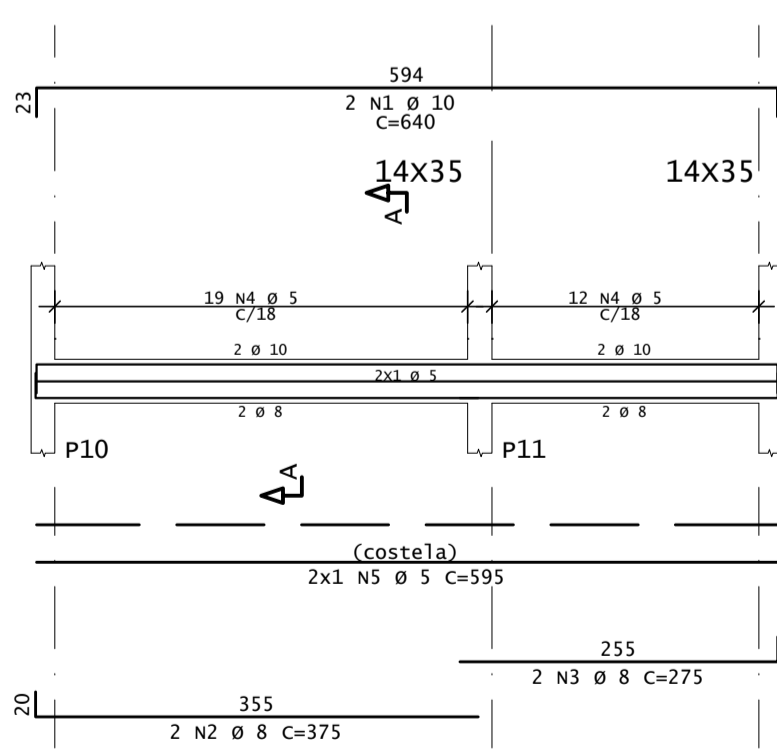

CORTE A

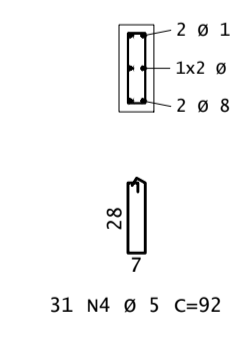

DIÂMETROS DE CURVATURA

Ø	8	10	12	16	20	22	25
db	4	5	6	8	10	12	14

AÇO	POS	BIT	QUANT	COMPRIMENTO		
				UNIT	TOTAL	
		mm		cm	cm	
V1	50	1	10	2	300	600
	50	2	12.5	2	250	500
	50	3	8	2	500	1000
	60	4	5	21	102	2142
	60	5	5	4	450	1800
V2	50	1	10	2	175	350
	50	2	8	2	675	1350
	50	3	10	2	225	450
	50	4	8	2	325	650
	50	5	8	2	325	650
	50	6	8	2	350	700
	60	7	5	15	85	1275
	60	8	5	35	92	2720
	60	9	5	2	925	1850
V3	50	1	12.5	2	200	400
	50	2	10	2	375	750
	50	3	8	2	400	800
	50	4	8	2	375	750
	50	5	8	2	525	1050
	60	6	5	30	92	2760
	60	7	5	14	85	1190
	60	8	5	2	835	1670
V4	50	1	12.5	5	400	2000
	50	2	12.5	4	200	800
	50	3	8	2	720	1440
	50	4	6.3	40	103	4120
	50	5	8	4	680	2720
V5	50	1	8	2	395	790
	50	2	8	2	375	750
	60	3	5	16	102	1632
	60	4	5	4	335	1340
V6	50	1	8	3	150	450
	50	2	10	2	400	800
	50	3	10	3	250	750
	50	4	8	2	300	600
	50	5	8	2	425	850
	60	6	5	14	85	1190
	60	7	5	21	92	1932
	60	8	5	2	650	1300
V7	50	1	10	2	640	1280
	50	2	8	2	375	750
	50	3	8	2	275	550
	60	4	5	31	92	2852
	60	5	5	2	595	1190

RESUMO DE AÇO			
AÇO	BIT	COMPR	PESO
	mm	m	kgf
60	5	273	42
50	6.3	41	10
50	8	159	63
50	10	50	31
50	12.5	37	36
<b>Peso Total</b>		<b>60 =</b>	<b>42 kgf</b>
<b>Peso Total</b>		<b>50 =</b>	<b>139 kgf</b>

ASSINATURAS E APROVAÇÃO

PROJETISTA:  PROPRIETÁRIO:  
LEONARDO SILVEIRA LIMA  
ENGENHEIRO CIVIL - RNP: 0601581067

APROVAÇÃO

GEOPAC RUA CALOUSTO NACHADO, 197, SALA 14  
BARRIO PRES. FACHINI, URUGUAY  
TEL: 051 3241 3141 EMAIL: GEOPAC@GEOPAC.COM.BR

PROPRIETÁRIO:  
PREFEITURA MUNICIPAL DE ARACATI

TÍTULO:  
CONSTRUÇÃO DA SEDE DOS BUGUEIROS E ANEXO DE INFORMAÇÕES

PROJETO:  
ESTRUTURAL DA CENTRAL DE TURISMO

IDENTIFICAÇÃO DOS DESENHOS:  
VIGAS

TÍTULO:  
ARACATICE PRESENÇA: ARIELLY EDUARDA ESCALA: INDICADA DATA: 30/NOV PRODUTOR: 04/09 ARQUIVO: